



Installation Instruction

TL400B

Before Installation

Diagram

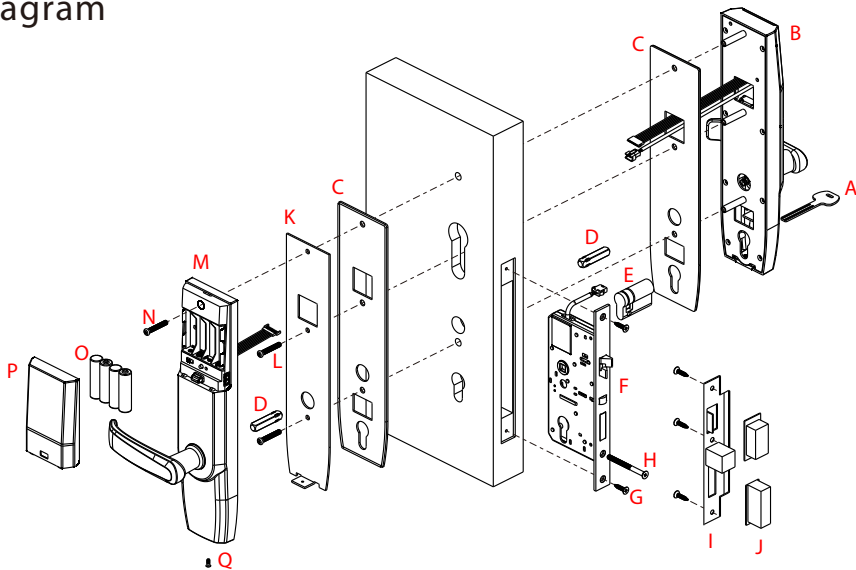

Packing List

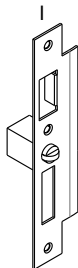
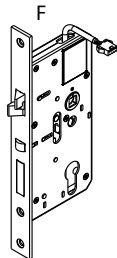
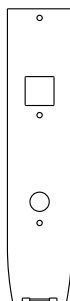
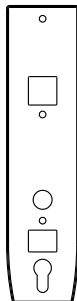
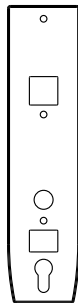
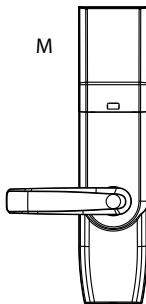
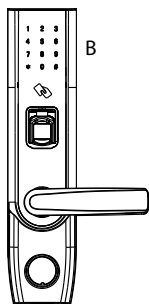

Mounting Hardware
Package 35-50mm door
thickness

Mounting Hardware
Package 50-65mm door
thickness

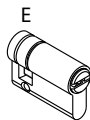
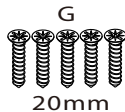
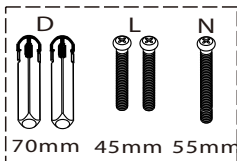
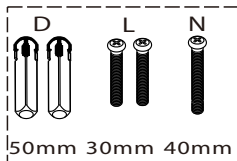

Cautions

1. The default setting of the device allows ANY fingerprint to unlock.
2. Please register at least one administrator for the newly installed lock. Without administrator, no registration for any normal user is allowed.
3. The lock is equipped with mechanical keys for manually unlocking. Please keep the mechanical keys in a safe place.
4. To power on the lock, four alkaline AA batteries (not included) are required. Non-alkaline and rechargeable batteries ARE NOT RECOMMENDED.
5. Do not remove batteries when the lock is in working state.
6. Please replace the battery soon when the lock prompts the voice of low battery.
7. There are 7 seconds stand-by time limits for all setting operations, without any activity within the time limits, the lock will automatically shut off.
8. Keep your fingers clean when using this lock.

Door Preparation

1. Check door thickness, prepare the mounting hardware package and cylinder.

Door Thickness (mm)	D Spindle Length (mm)	N Screw Length (mm)	L Screw Length (mm)	Q Screw Length (mm)	E Cylinder Length (mm)
35-50	50	40	30	8	40
50-65	70	55	45	8	50
65-80	70	70	60	8	60

Note : The standard lock includes 2 mounting hardware packages only, which are used for the door thickness of 35-50mm and 50-65 mm separately.

2. Check door open direction.

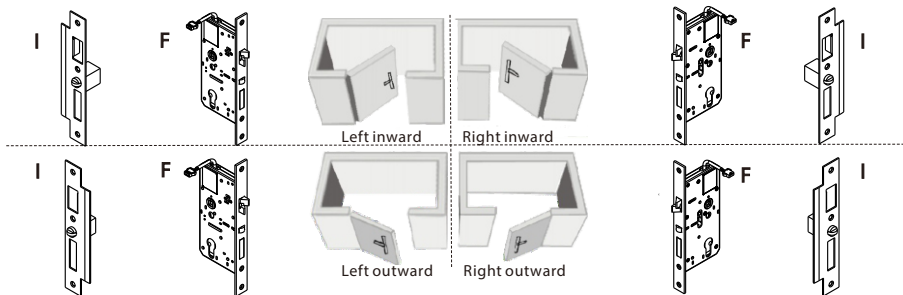

Note 1: There are 2 types of mortise (F): one is for left open, the other is for right open. Please use the correct one.

Note 2: There are 2 types of strike plate (I): one is for inward open, the other is for outward open. Please use the correct one.

Tips

How to change the handle direction?

Press down the component pointed by the arrow.
At the same time, rotate the handle at 180°.
Then release your hand from the pressed component.

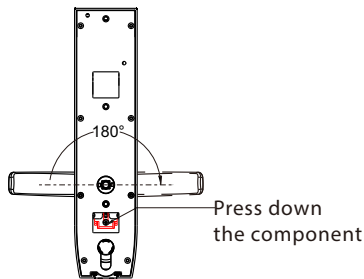

Installation

1. Drill holes on the door.

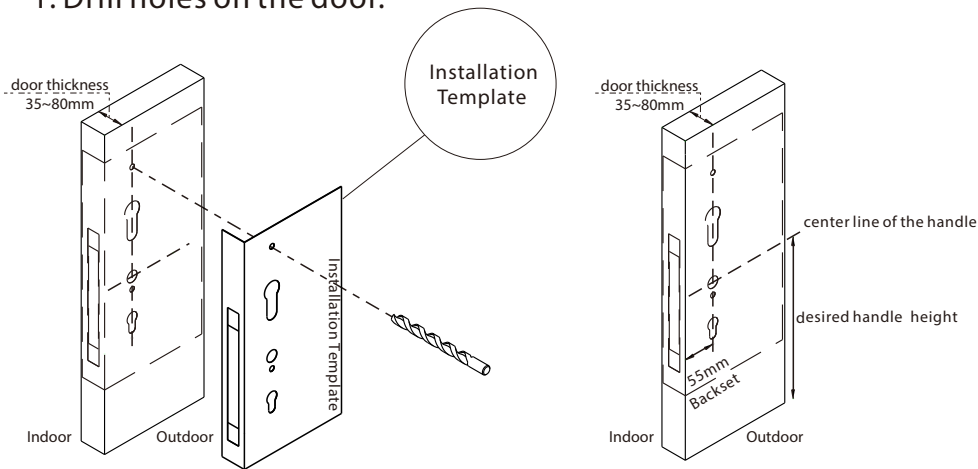

Note 1: Align the template along the vertical center line of the mortise (F) at the desired handle height, and tape it to door.

Note 2: Mark the holes first, then start drilling.

Installation

2. Install the mortise(F).

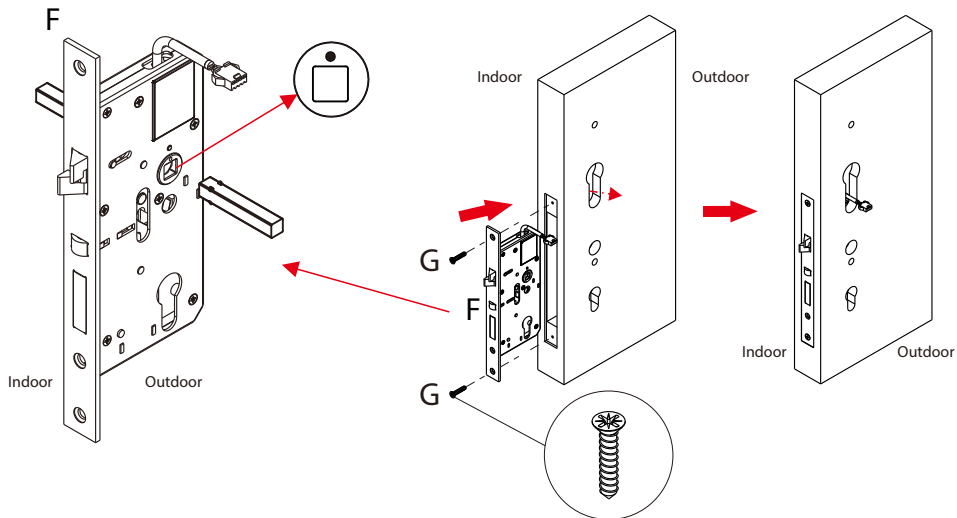

3. Install lock cylinder(E).

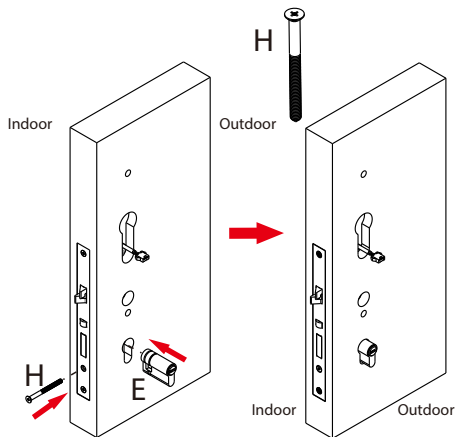

Note: Install lock cylinder in right direction, then tighten screw (H) to fix it.

4. Install spindle(D).

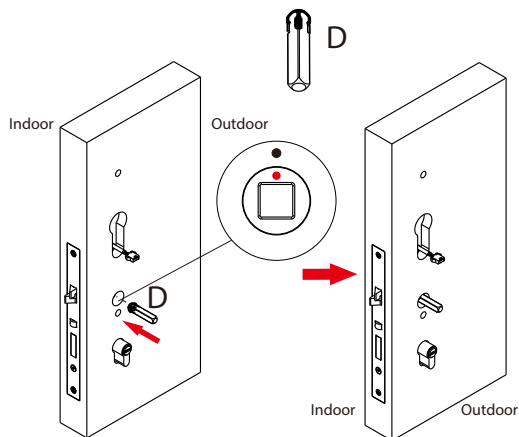

Note: Ensure the dot of clutch is vertically upward.

5. Install outdoor unit(B) with gasket(C).

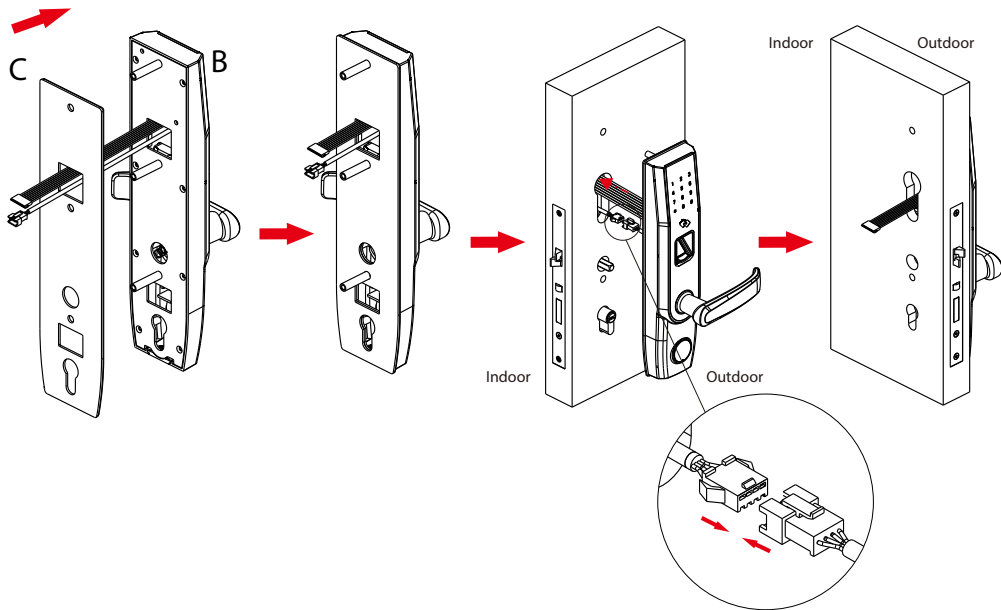

6. Install mounting plate (K) with gasket (C) on the door.

7. Install spindle (D) on the door.

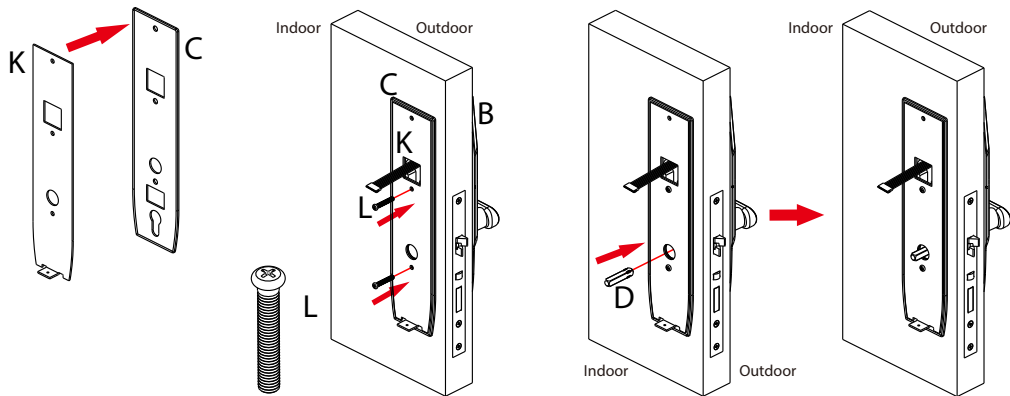

8. Install indoor unit (M).

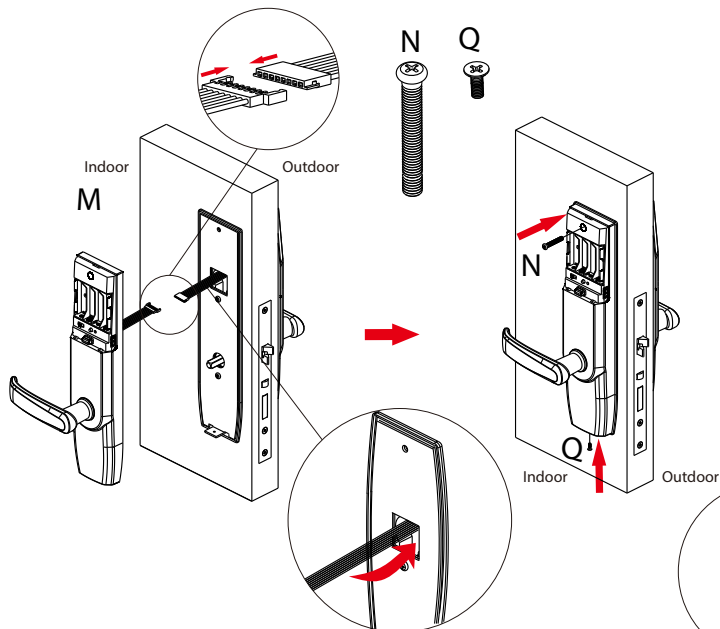

Note: Push cable into the hole .

9. Install the battery (O).

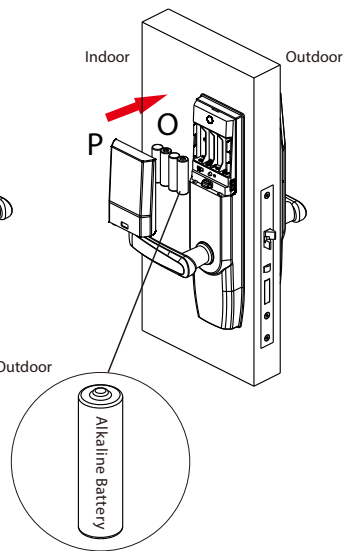

10. Mark and drill holes for striking.

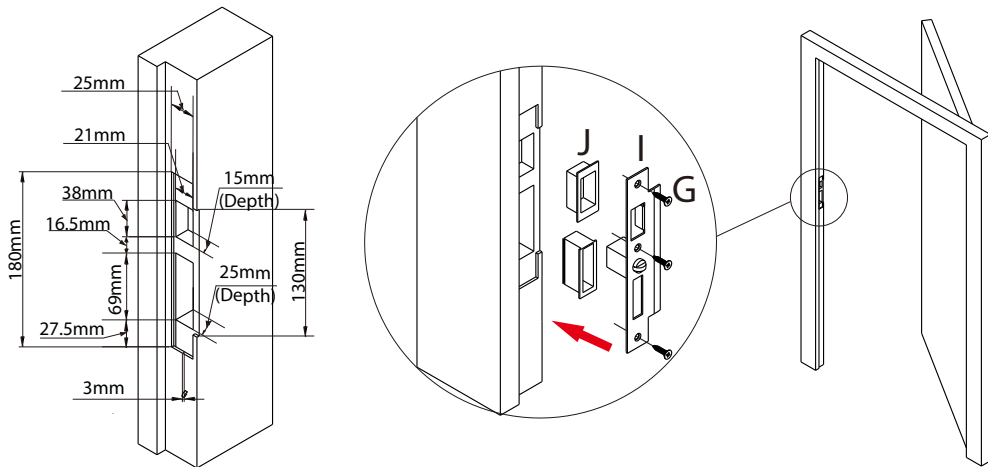

11. Test the lock by mechanical key(A) or registered fingerprint.

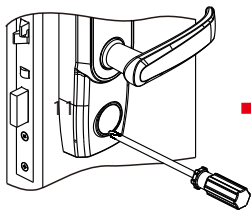

Remove the cover on the key hole with screwdriver or nails.

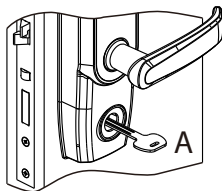

Insert the key into key hole and rotate 90°.

Note: AB key system (please refer to the explanation below) is available for this model, if you need this function, please contact the sales.

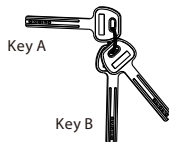
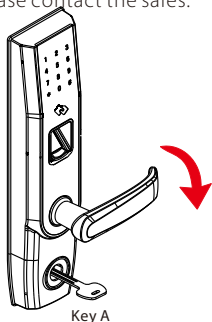

Mechanical Key Instruction:

1. Key A is coated with brass color, which is used only for lock installer and upfitter.
2. Key B is packed in the sealed plastic wrap for safety, which is used for house owner.
3. Once Key B is used, Key A will be disabled to open the lock.



#24, Shambavi Building, 23rd Main, Marenahalli, JP Nagar 2nd Phase, Bengaluru - 560078
Phone : 91-8026090500 | Email : sales@esslsecurity.com
www.esslsecurity.com